

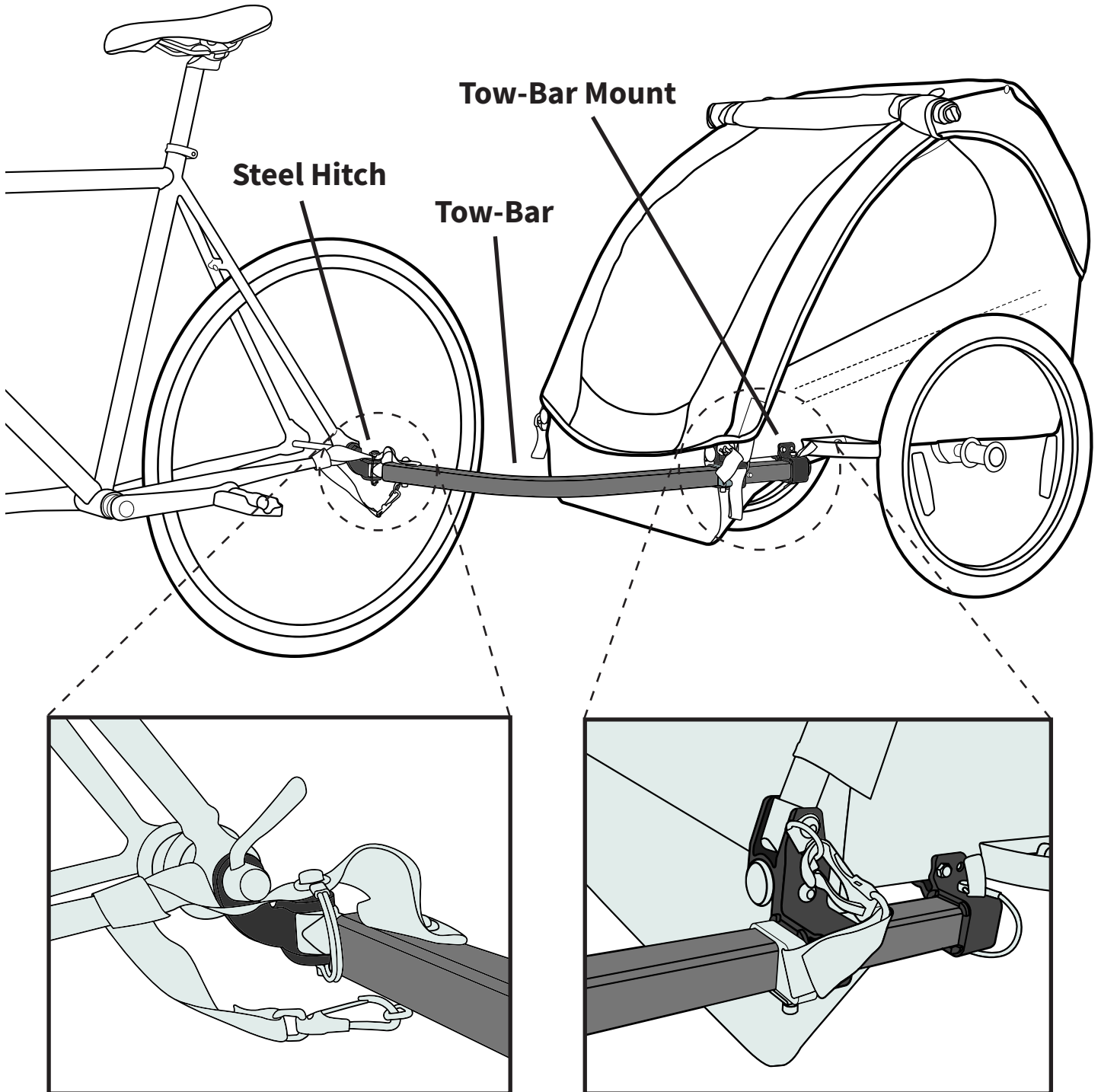

Burley Hitch and Adapter Guide

This guide will help you determine if you can attach your trailer out of the box, or if you will require an additional part.



Every Burley trailer comes equipped with a Steel Hitch, Tow-Bar and Tow-Bar Mount. In most cases this is all you will need to safely connect the trailer to your bicycle. In some cases you may require an additional adapter or thru-axle. This guide will help you determine if you require one of these additional parts, and if so, which part you require.

1

The first step is to identify the type of axle your bike has. There are 3 main types of axles.

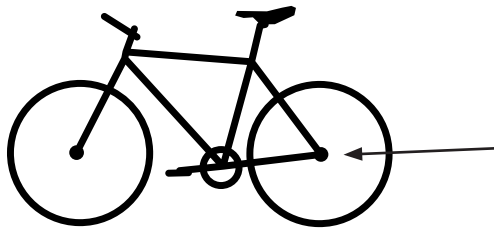

The axle is located here. It goes through the rear wheel of the bicycle.

Quick Release Axle

The most common type of axle. The quick release axle has a lever that clamps the axle in place with an acorn nut on the opposite end.

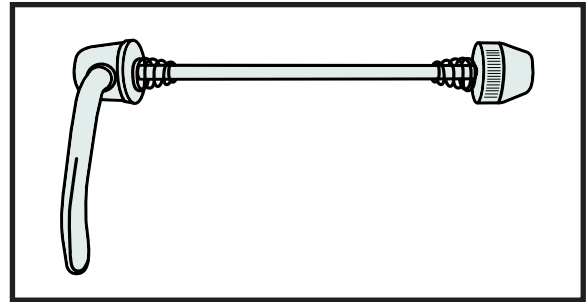

Bolt-on Axle

The Bolt-on Axle has a hex nut on both sides. It is common on fixed gear and single speed bicycles, as well as internally geared hubs.

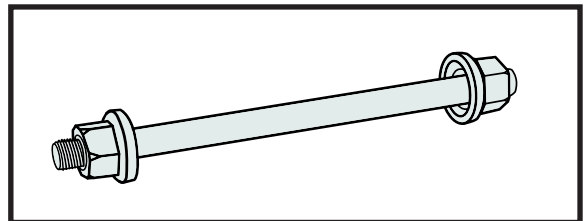

Thru Axle

Thru axles are thick and hollow. They are common on newer bicycles with disc brakes, especially mountain bikes.

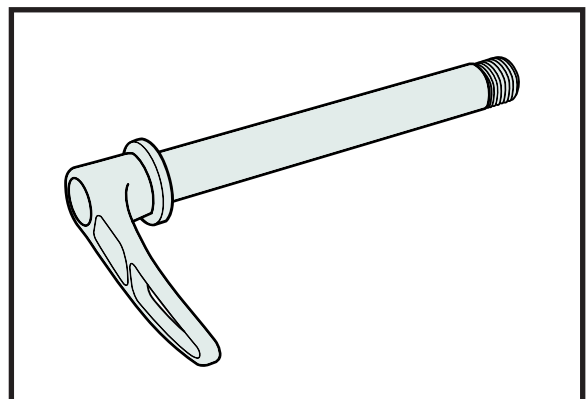

Not all axles will look exactly like the samples shown here. If you are unsure about your axle type please consult with your local bike shop. Now that you have determined your axle type, move to step 2.

2

The 2nd step is to determine your dropout type. There are many types of dropouts, but for the purposes of hitching a Burley Trailer, we can group them into 2 main categories.

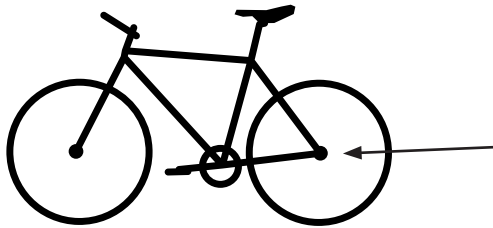

The dropouts are located here. They are the two slots that the axle connects to. They hold the rear wheel in place.

Standard Dropout

Most bicycles will have a standard dropout. They won't all look like this, but the key thing to look for is a flat area around and below the axle where the Steel Hitch can lay flush against the frame.

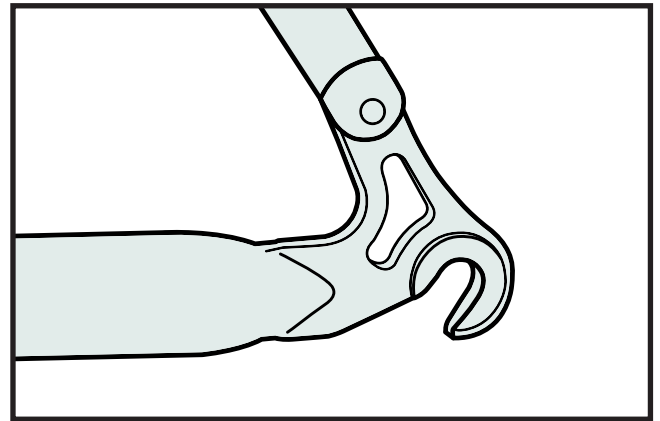

Hooded Dropout

Hooded dropouts have a protruding metal hood that extends around the top of the dropout. They are common on custom or hand-made bikes. They can prevent the Steel Hitch from lying flush against the frame. This problem is solved by the adapters which you will read about later.

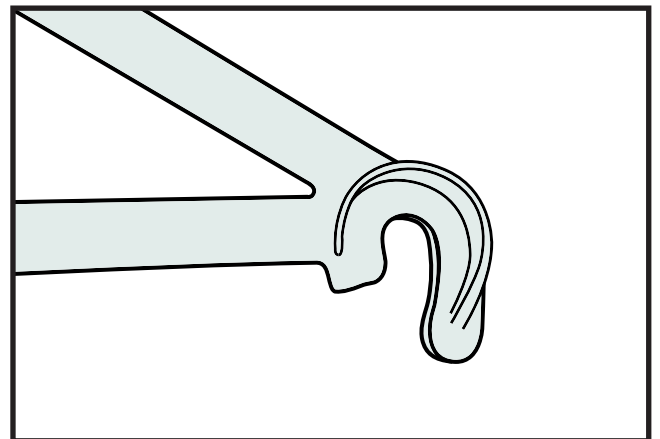

Not all dropouts will look exactly like the samples shown here. If you are unsure about your dropout type please consult with your local bike shop.

3

Now that you know what type of axle and dropout you have, use the table below to determine if you will need additional parts to connect your Burley trailer.

	Quick Release Axle	Bolt-On Axle	Thru Axle
Standard Dropout	Steel Hitch (Included)	Steel Hitch* (Included)	Steel Hitch <i>(Included)</i> + Burley Thru Axle
Hooded Dropout	Steel Hitch <i>(Included)</i> + Adapter	Steel Hitch <i>(Included)</i> + Adapter	Steel Hitch <i>(Included)</i> + Burley Thru Axle

Most people will have a Standard Dropout paired with a Quick Release, and **will therefore not require any extra parts**. If you **do** require an extra part, keep reading.

Q: What does the adapter do for me?

A: You will need an adapter if your dropout does not have room for the hitch to lay flush against the bike frame, or in some cases, if the addition of the hitch makes the axle too short for the nut to be re-installed. In these cases the adapter acts as a spacer. It provides a flat surface away from the dropout that allows the hitch to lay flush to a solid surface. In the case of axles being too short to be reinstalled, it extends the length of the axle so that it can be safely installed with the hitch.

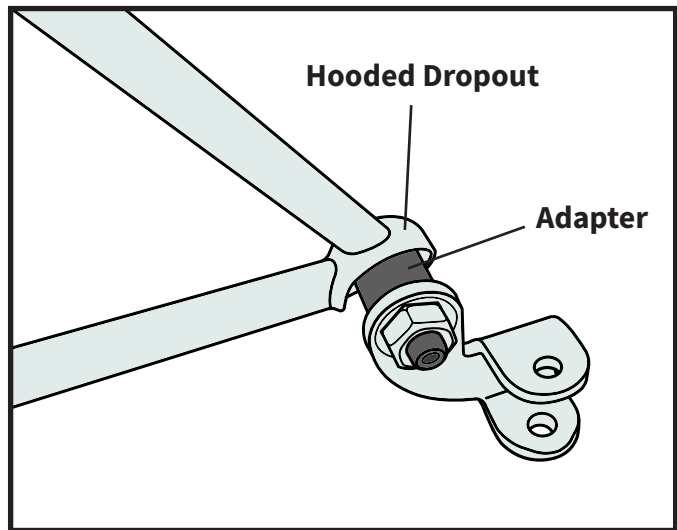

Q: I see there are multiple sizes of Adapters and Thru Axles how do I know which part is right for me?

A: It will depend on the size and threading of your axle. Use the Adapter Guide and Axle Fit Guide on the following pages to determine which part is right for you.

*It is possible that the addition of the Steel Hitch may make your bolt on axle too short for the nut to be re-installed. If this is the case you will require an adapter.

Burley Adapter Guide

If you need an adapter this guide will help you determine which model is right for you.

There are four adapter models:

QR
3/8 x 26
M10 x 1.0
M10.5 x 1.0

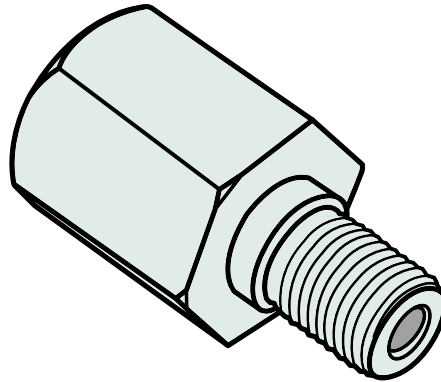

QR (Quick Release) Adapter

If you have a Quick Release Axle you will need the QR Adapter. This is the most commonly used adapter.

All Others

The other three models will all apply to bolt-on axles. You must know the Diameter and Thread Pitch of your axle. This information should be acquired from your bicycle/axle/hub manufacturer. Then select the appropriate Adapter according to the axle diameter and thread pitch, which is indicated in the adapter name.

Diameter **Pitch**

⎵ ⎵

M10 x 1.0

Instructions for installing the adapter will be included with the adapter.
Adapters can be ordered online at burley.com

THRU AXLE FIT GUIDE

IMPORTANT: This guide is intended for axles used with the hitch mounted trailers

1. Print this sheet. Verify that the illustrations are to scale by using this ruler.

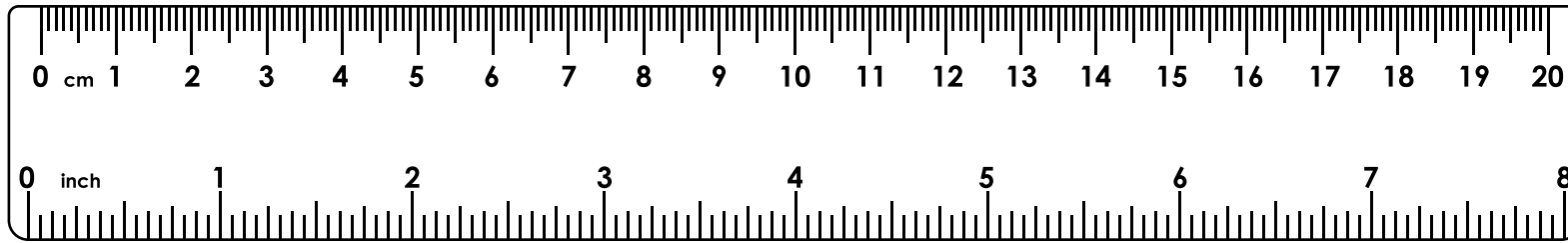

2. Check the thread pitch of your current axle by comparing it to the illustrations here.



1mm

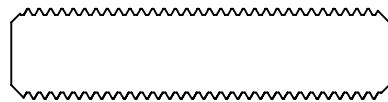

1.5mm

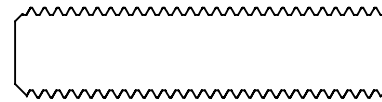

1.75mm

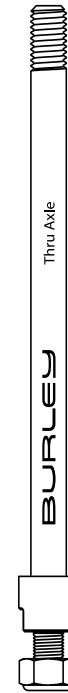

*Not to scale

3. Measure the length of your current axle using this illustration. Measure to the end of the threads.

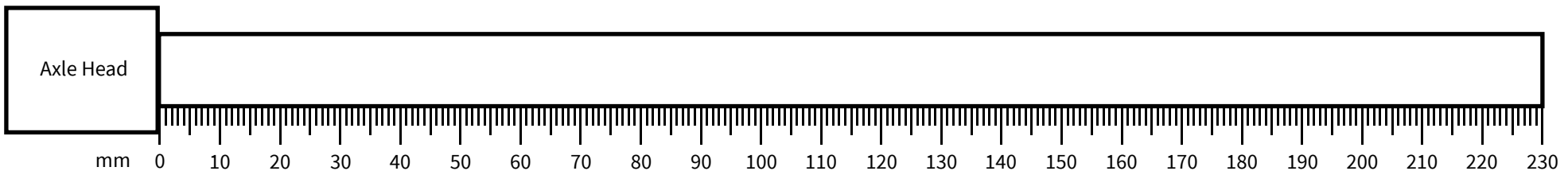

4. Use the thread pitch and axle length to determine which model of Thru Axle you need. If your axle length is not shown for the thread pitch you have, we do not have a compatible thru axle for you at this time.

Thread Pitch	Measured Axle Length	Compatible Burley Thru Axle	SKU
1.0	~160-174 mm	12x1.0, 142-148 mm	960120
1.5	~172-178 mm	12x1.5, 142-148 mm	960121
1.5	~229 mm	12x1.5, 197 mm	960124
1.75	~174-180	12x1.75, 142-148 mm	960122
1.75	~229	12x1.75, 197 mm	960123